

Data Sheet

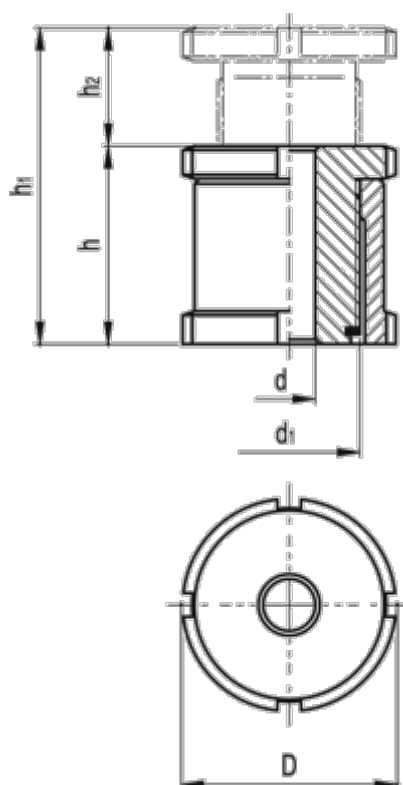

Article number: 20660235B
Description: E+G Levelling set
GN 350-58-22-A-ST

Measures



C-spanner DIN 1810 = A58-62
 d = 22.0
 D = 58
 d_1 = M40x1
For screw = M20
 h = 54
 h_1 = 86
 h_2 = 32

Max static load (N) = 210.0
Static preload (N) = 90.0
Weight (g) = 730